

M-Pulse Microwave

Silicon Bipolar MMIC Cascadable Amplifier

MP4TD1135, MP4TD1136

Features

- High Dynamic Range Cascadable
50Ω/75Ω Gain Block
- 3dB Bandwidth: 50 MHz to 1.0 GHz
- 17 dBm Typical P_{1dB} @ 0.7 GHz
- 11 dB Typical Gain @ 0.5 GHz
- 4.0 dB Typical Noise Figure @ 0.7 GHz
- Cost Effective Ceramic Microstrip Package
- Tape and Reel Packaging Available

Description

M-Pulse's MP4TD1135 and MP4TD1136 are high performance silicon bipolar MMICs housed in cost effective ceramic microstrip packages. The MP4TD1135 and MP4TD1136 are designed for use in 50Ω or 75Ω systems where a high dynamic range gain block is required. Typical applications include narrow and wide band IF and RF amplifiers in industrial and military applications.

The MP4TD1135 and MP4TD1136 are fabricated using a 10 GHz f_T silicon bipolar technology that features gold metallization and IC passivation for increased performance and reliability.

Ceramic Microstrip Case Style Outlines^{1,2,3}

Available in short lead version as MP4TD1136.

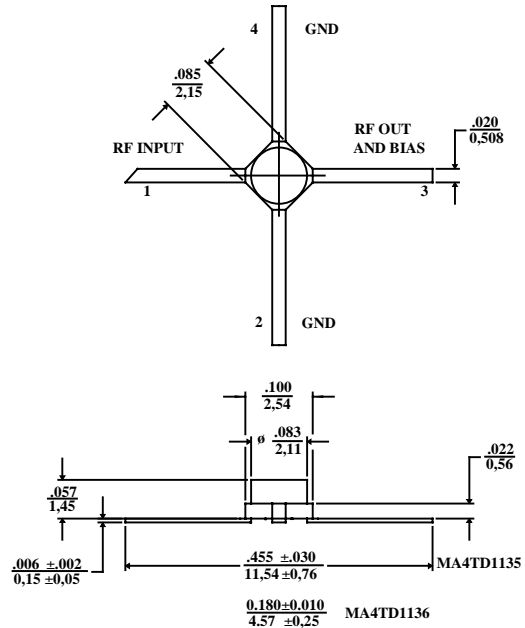

Notes: (unless otherwise specified)

1. Dimensions are in / mm
2. Tolerance: in .xxx = ±.005; mm .xx = ±.13
3. See last page of data sheet for short lead Micro-X

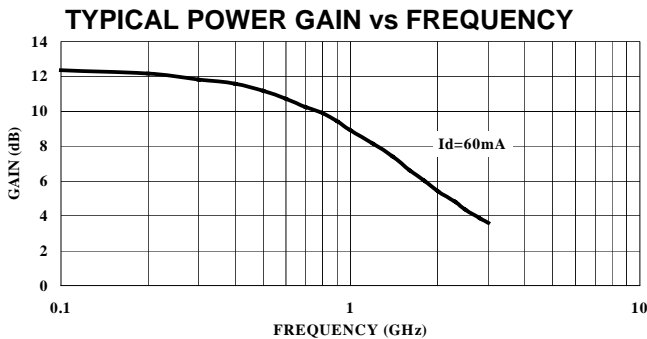

Pin Configuration

Pin Number	Pin Description
1	RF Input
2 & 4	AC/DC Ground
3	RF Output and DC Bias

Electrical Specifications @ $T_A = +25^\circ\text{C}$, $I_D = 60 \text{ mA}$, $Z_0 = 50\Omega$

Symbol	Parameters	Test Conditions	Units	Min.	Typ.	Max.
G_p	Power Gain ($ S_{21} ^2$)	$f = 0.1 \text{ GHz}$	dB	11.5	12.5	13.5
ΔG_p	Gain Flatness	$f = 0.1 \text{ to } 0.7 \text{ GHz}$	dB	-	± 0.9	± 1.1
f_{3dB}	3 dB Bandwidth	ref 50 MHz Gain	GHz	-	1.0	-
SWR _{in}	Input SWR	$f = 0.1 \text{ to } 2.0 \text{ GHz}$	-	-	2.0	-
SWR _{out}	Output SWR	$f = 0.1 \text{ to } 2.0 \text{ GHz}$	-	-	1.9	-
P_{1dB}	Output Power @ 1dB Gain Compression	$f = 0.7 \text{ GHz}$	dBm	16.0	17.0	-
NF	50 Ω Noise Figure	$f = 0.7 \text{ GHz}$	dB	-	4.0	4.5
IP ₃	Third Order Intercept Point	$f = 1.0 \text{ GHz}$	dBm	-	30.0	-
t_D	Group Delay	$f = 1.0 \text{ GHz}$	ps	-	160	-
V _d	Device Voltage	-	V	4.5	5.5	6.5
dV/dT	Device Voltage Temperature Coefficient	-	mV/°C	-	-8.0	-

Specification Subject to Change Without Notice

Absolute Maximum Ratings¹

Parameter	Absolute Maximum
Device Current	90 mA
Power Dissipation ^{2,3}	560 mW
RF Input Power	+20 dBm
Junction Temperature	200°C
Storage Temperature	-65°C to +200°C
Thermal Resistance: $\theta_{jc} = 135^\circ\text{C/W}$	

1. Exceeding these limits may cause permanent damage.
2. Case Temperature (T_c) = 25 °C.
3. Derate at 6.9 mW/°C for $T_c > 124^\circ\text{C}$.

Typical Bias Configuration

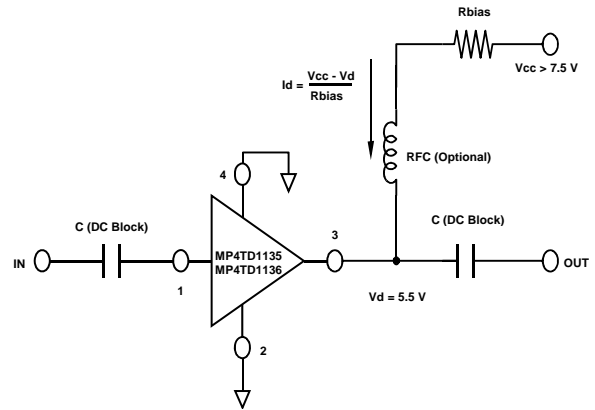

Typical Performance Curves @ $I_d = 60\text{ mA}$, $T_A = +25^\circ\text{C}$ (unless otherwise noted)

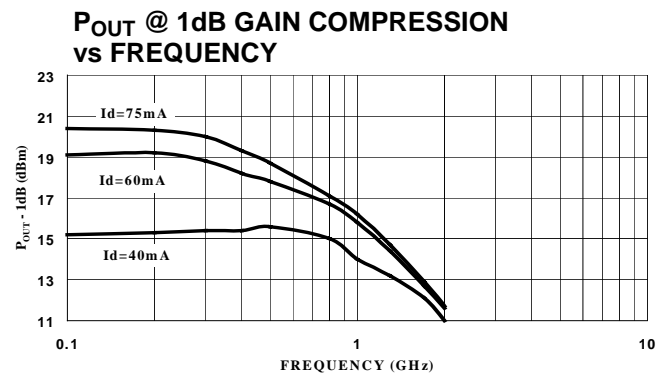
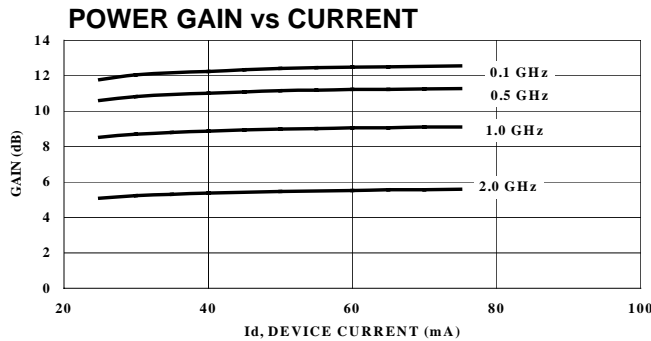
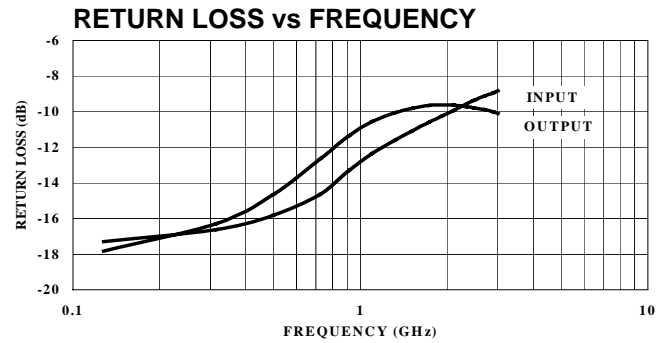
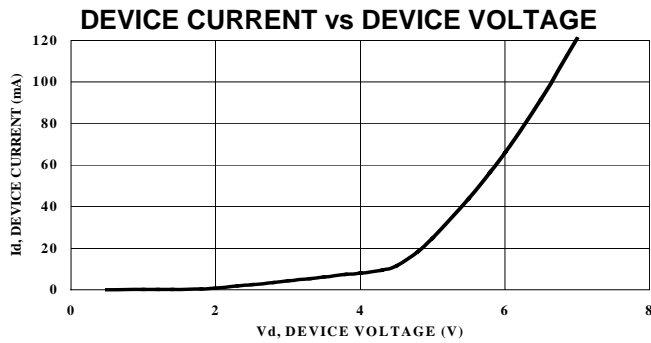

Specification Subject to Change Without Notice

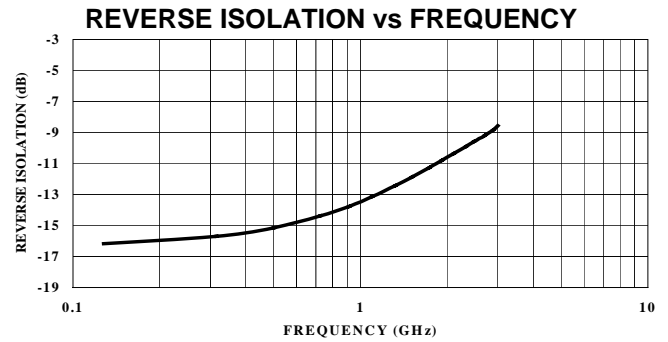
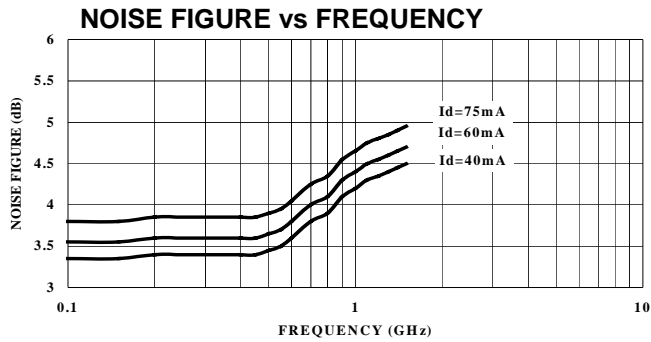

Typical Scattering Parameters

$Z_0 = 50\Omega$, $T_A = +25^\circ\text{C}$, $I_d = 60\text{ mA}$

Frequency (GHz)	S11		S21		S12		S22	
	Mag.	Angle	Mag.	Angle	Mag.	Angle	Mag.	Angle
0.05	0.133	-104.9	4.23	157.5	0.152	14.4	0.120	-98.7
0.1	0.134	-106.7	4.19	156.2	0.154	14.8	0.124	-100.6
0.2	0.140	-112.4	4.05	151.7	0.158	16.2	0.137	-106.6
0.3	0.148	-118.6	3.90	146.8	0.164	17.7	0.153	-113.1
0.4	0.153	-123.0	3.79	143.2	0.168	18.8	0.165	-120.2
0.5	0.162	-129.9	3.62	137.8	0.174	20.5	0.185	-125.1
0.6	0.172	-137.3	3.44	131.2	0.182	22.4	0.208	-132.8
0.7	0.185	-144.4	3.25	124.7	0.190	24.6	0.233	-140.8
0.8	0.198	-148.7	3.12	120.4	0.196	26.3	0.249	-145.3
0.9	0.216	-154.6	2.95	114.4	0.205	28.4	0.271	-151.4
1.0	0.232	-159.8	2.79	108.8	0.214	30.3	0.287	-156.8
1.5	0.279	-179.0	2.23	89.4	0.254	35.8	0.323	-175.4
2.0	0.314	164.8	1.88	74.3	0.294	38.7	0.331	169.7

Ordering Information

Long Lead Model No.	Short Lead Model No.	Package
MP4TD1135	MP4TD1136	Ceramic
MP4TD1135T	MP4TD1136T	Tape and Reel

Mico-X Case Styles

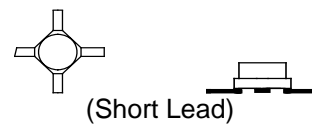
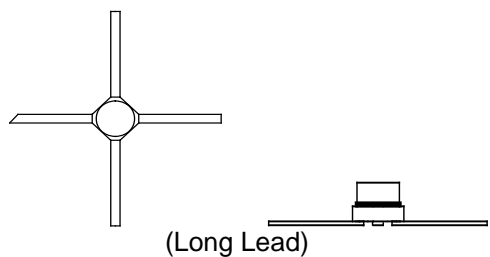

Specification Subject to Change Without Notice